



EPEL Catalogue

 | 주 | 에 펠

VOLUME 2

(주) 에펠

1. 풍부한 기술력이 바탕이 된 기업

도로조명, 주거단지, 공원 등의 아름다운 도시경관조성을 위한 기능적이고 환경 친화적인 공공시설물 제작 및 설치에 기술력과 노하우를 겸비한 기업으로, 다수의 특허와 디자인 등록 및 서울 우수공공디자인, 경기도 공공시설물 우수디자인, 인천 굿디자인 등을 보유하고 있습니다.

2. 끊임없이 발전을 도모하는 창의적인 기업

빠르게 변화하는 시대에 한 발 앞서 준비하고 실천하는 기업으로, 주변 환경과 어울리는 색채와 디자인을 최고 품질의 제품으로 구현하기 위하여 창의적이고 적극적인 연구개발에 힘쓰는 성장하는 기업입니다.

3. 스마트가로등 개발의 선두 기업

스마트 시대에 맞춰 스마트시티 도시기반 시설인 스마트가로등을 개발 하였으며, 스마트 서비스에 대한 연구 개발에 전력을 다하여 오늘보다 내일이 더 나은 기업이 되겠습니다.





목차
Contents

1. 가로등주	5
2. 보안등주	18
3. 가로등주 부속자재	29
4. 등기구	36
5. LED 경관조명기구	44
6. 블라드	63
7. 스마트 가로등 및 스마트 폴	65



1 가로등주

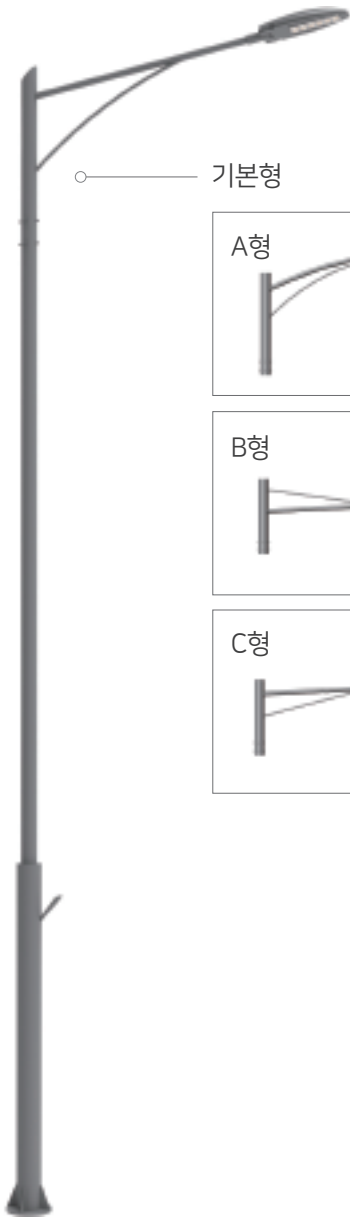

기본형

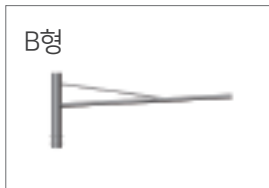
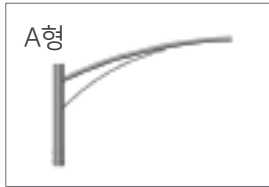

EPSS05

MODEL	MATERIAL	SIZE(H)	물품식별번호
EPSS05-081	STEEL	8m	22652537
EPSS05-08(5)1	STEEL	8.5m	22652538
EPSS05-091	STEEL	9m	22541920
EPSS05-101	STEEL	10m	22541921

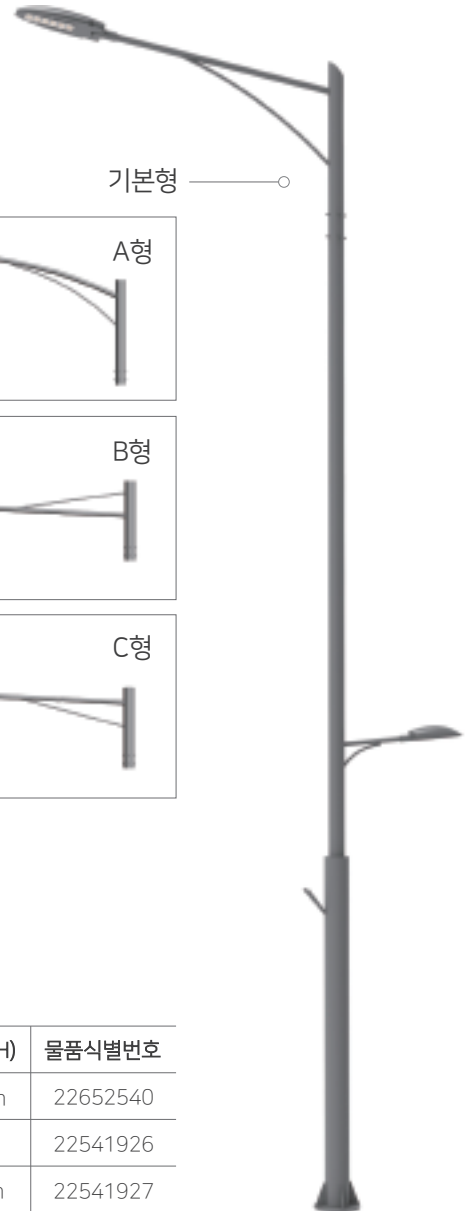

기본형

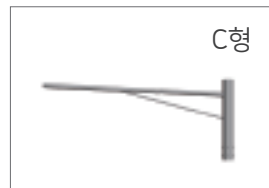
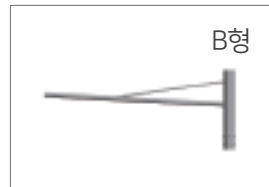

EPSS05-1

MODEL	MATERIAL	SIZE(H)	물품식별번호
EPSS05-08(5)1-1	STEEL	8.5m	22652540
EPSS05-091-1	STEEL	9m	22541926
EPSS05-101-1	STEEL	10m	22541927

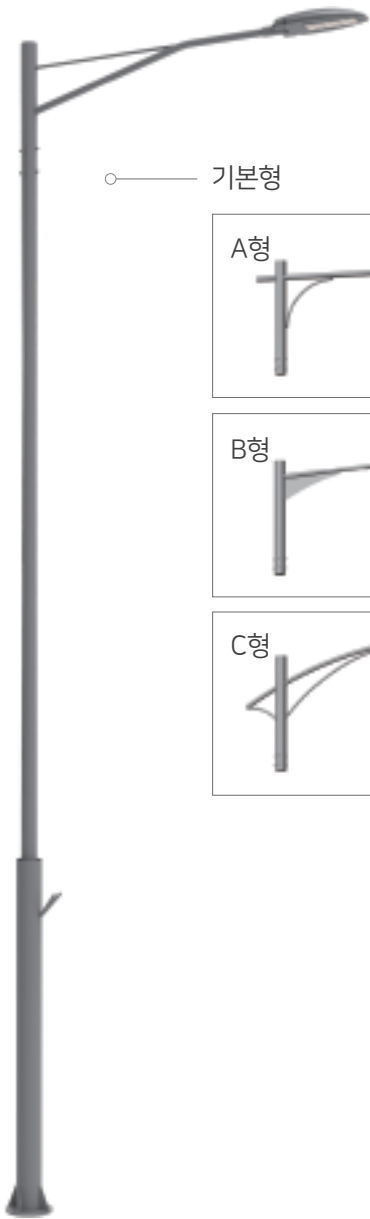

○ 기본형

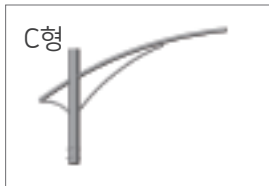
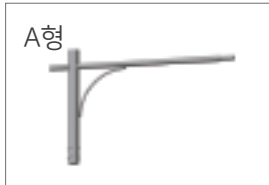

EPSS08

MODEL	MATERIAL	SIZE(H)	물품식별번호
EPSS08-08(5)1	STEEL	8.5m	22656467
EPSS08-101	STEEL	10m	22656469

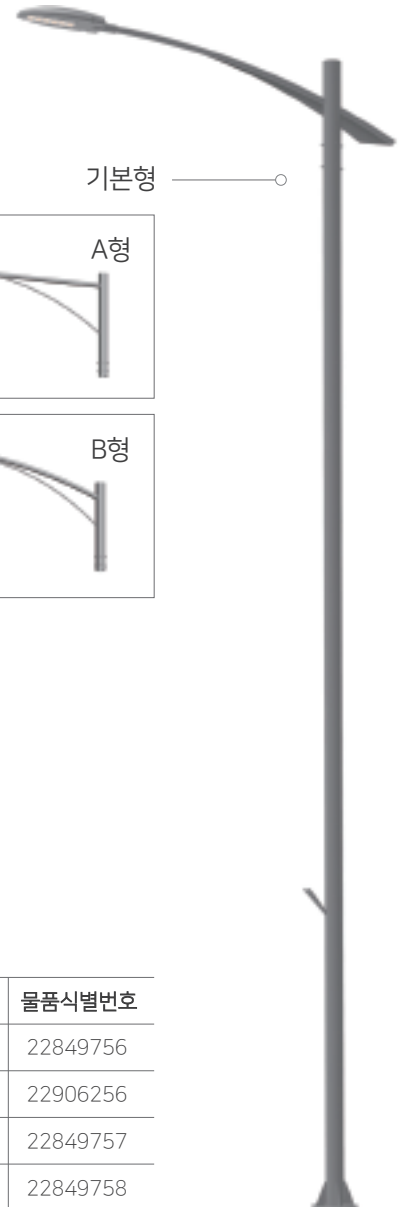

○ 기본형

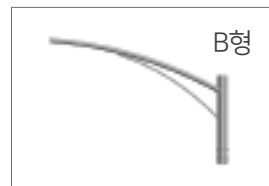
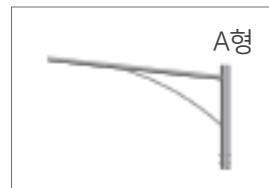

EPSS12

MODEL	MATERIAL	SIZE(H)	물품식별번호
EPSS12-081	STEEL	8m	22849756
EPSS12-0851	STEEL	8.5m	22906256
EPSS12-091	STEEL	9m	22849757
EPSS12-101	STEEL	10m	22849758

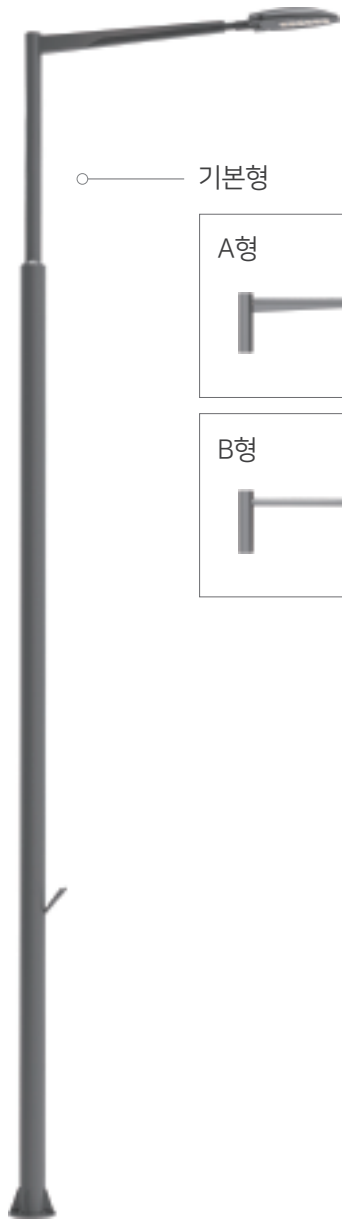

기본형

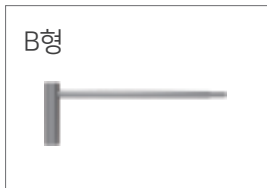

EPSS15

MODEL	MATERIAL	SIZE(H)	물품식별번호
EPSS15-081	STEEL	8m	23060419
EPSS15-091	STEEL	9m	23060421
EPSS15-101	STEEL	10m	23060422

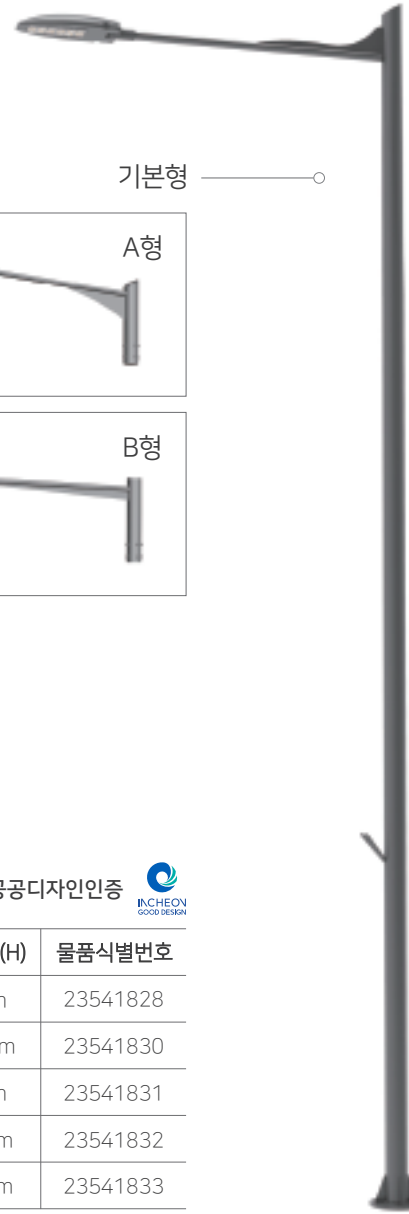

기본형

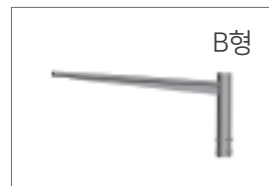
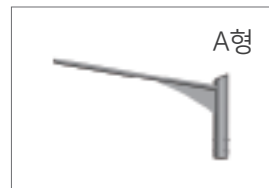

EPSS20

공공디자인인증 

MODEL	MATERIAL	SIZE(H)	물품식별번호
EPSS20-081	STEEL	8m	23541828
EPSS20-0851	STEEL	8.5m	23541830
EPSS20-091	STEEL	9m	23541831
EPSS20-101	STEEL	10m	23541832
EPSS20-121	STEEL	12m	23541833



EPSS22

MODEL	MATERIAL	SIZE(H)	물품식별번호
EPSS22-081	STEEL	8m	23541807
EPSS22-0851	STEEL	8.5m	23541858
EPSS22-091	STEEL	9m	23541808
EPSS22-101	STEEL	10m	23541859

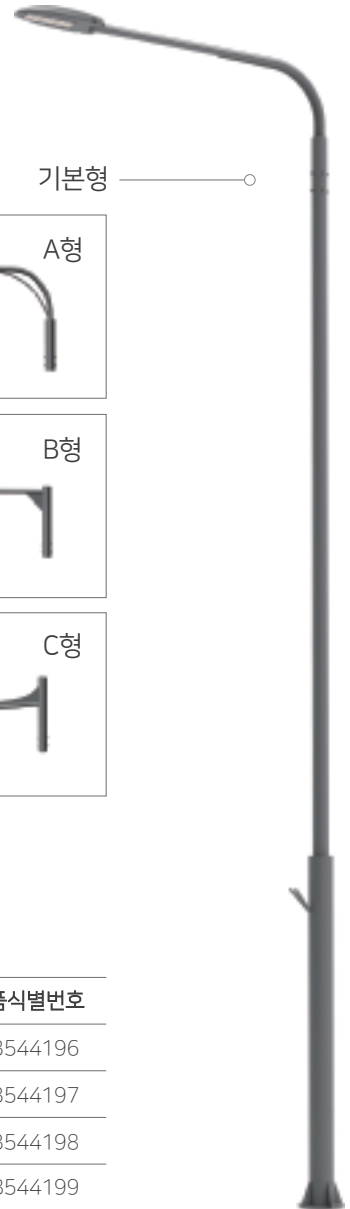

기본형

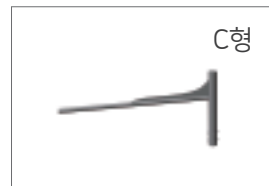
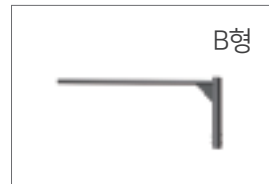

EPSS23

MODEL	MATERIAL	SIZE(H)	물품식별번호
EPSS23-081	STEEL	8m	23544196
EPSS23-0851	STEEL	8.5m	23544197
EPSS23-091	STEEL	9m	23544198
EPSS23-101	STEEL	10m	23544199

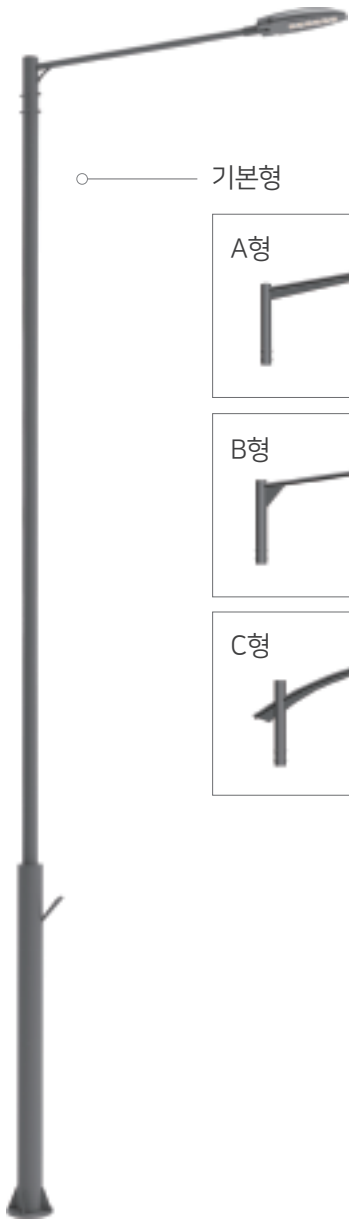

○ 기본형



EPSS24

MODEL	MATERIAL	SIZE(H)	물품식별번호
EPSS24-081	STEEL	8m	23544201
EPSS24-0851	STEEL	8.5m	23544202
EPSS24-091	STEEL	9m	23544203
EPSS24-101	STEEL	10m	23544204
EPSS24-121	STEEL	12m	23544205

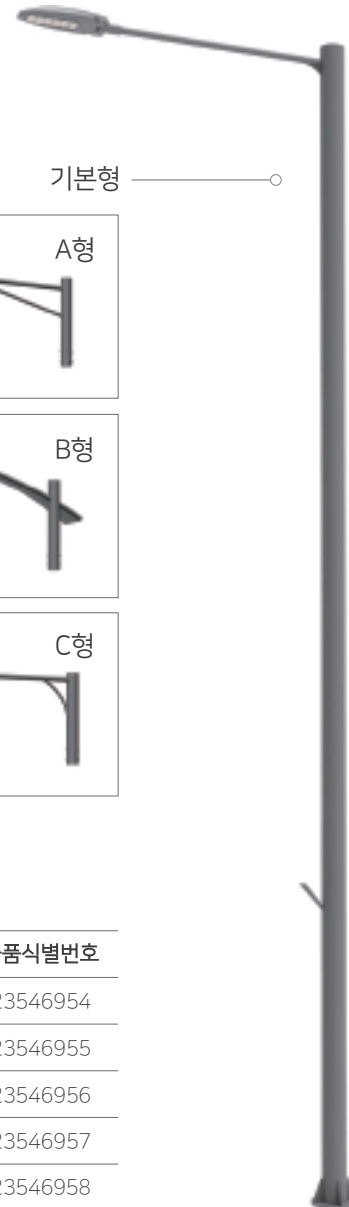

기본형 ○

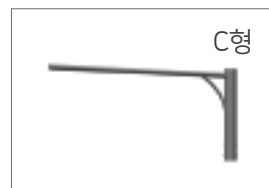
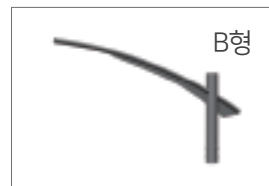
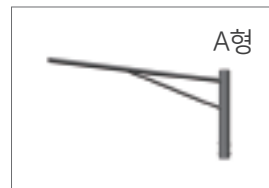

EPSS25

MODEL	MATERIAL	SIZE(H)	물품식별번호
EPSS25-081	STEEL	8m	23546954
EPSS25-0851	STEEL	8.5m	23546955
EPSS25-091	STEEL	9m	23546956
EPSS25-101	STEEL	10m	23546957
EPSS25-121	STEEL	12m	23546958

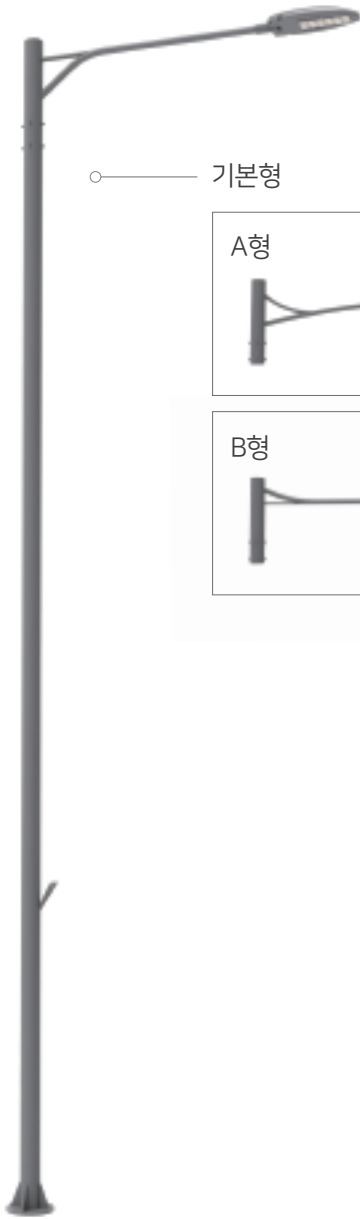

기본형

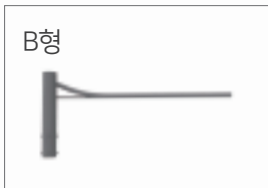
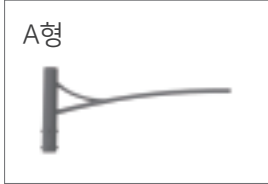

EPSS27

공공디자인인증 

MODEL	MATERIAL	SIZE(H)	물품식별번호
EPSS27-081	STEEL	8m	24115778
EPSS27-0851	STEEL	8.5m	24115779
EPSS27-091	STEEL	9m	24115780
EPSS27-101	STEEL	10m	24115781

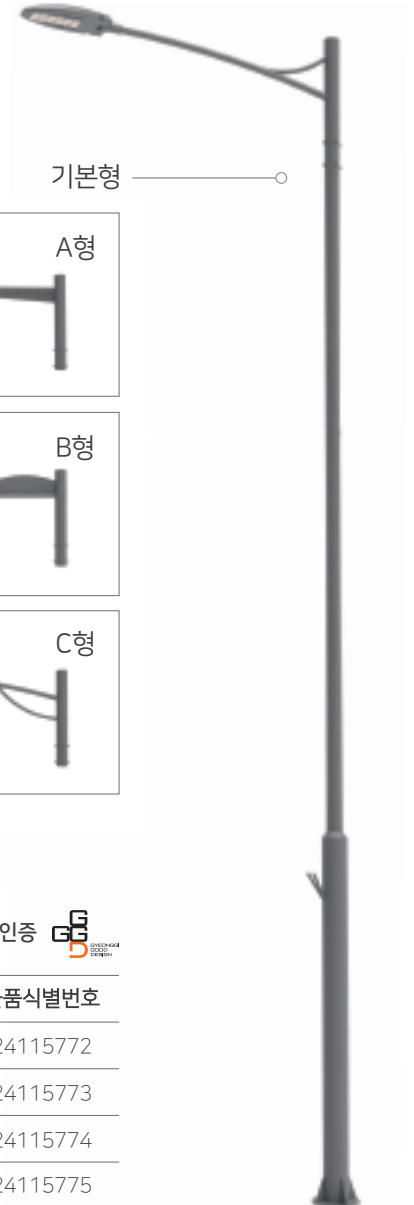

기본형



EPSS28

공공디자인인증 

MODEL	MATERIAL	SIZE(H)	물품식별번호
EPSS28-081	STEEL	8m	24115772
EPSS28-0851	STEEL	8.5m	24115773
EPSS28-091	STEEL	9m	24115774
EPSS28-101	STEEL	10m	24115775



EPSS(P)

MODEL	MATERIAL	SIZE(H)	물품식별번호
EPSS(P)-08-1	STEEL	6.5m	22652955
EPSS(P)-10-1	STEEL	8.5m	22652957

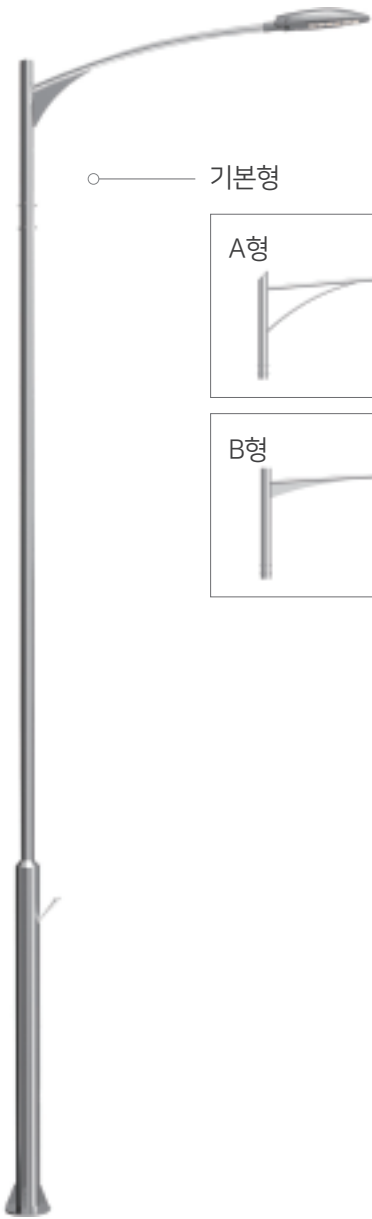

기본형

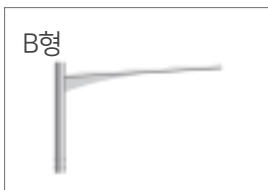
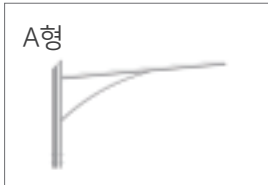

EPS05

MODEL	MATERIAL	SIZE(H)	물품식별번호
EPS05-081	STS	8m	22652645
EPS05-101	STS	10m	22652647

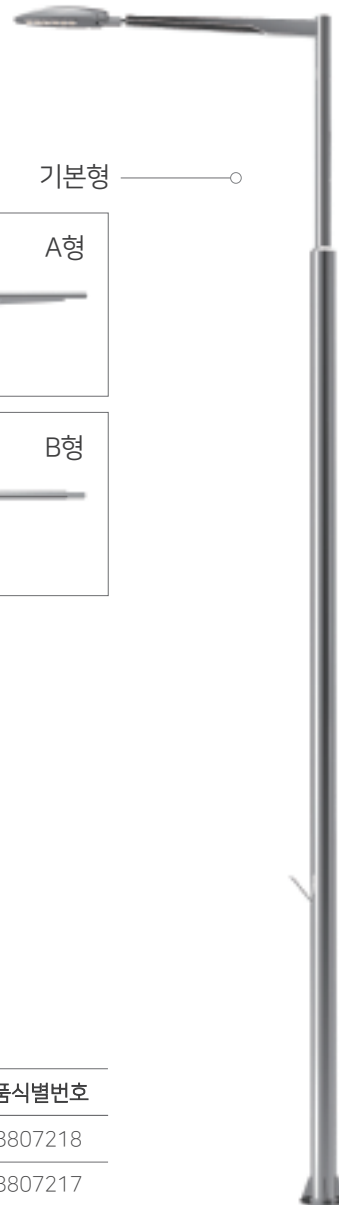

기본형

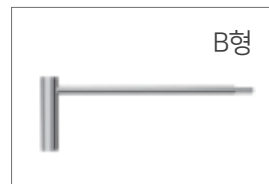

EPS06,07

MODEL	MATERIAL	SIZE(H)	물품식별번호
EPS06-0851	STS	8.5m	23807218
EPS07-101	STS	10m	23807217



EPAS01

MODEL	MATERIAL	SIZE(H)	물품식별번호
EPAS01-081	AL	8m	22657351
EPAS01-08(5)1	AL	8.5m	22657352
EPAS01-101	AL	10m	22657355
EPAS01-121	AL	12m	22657358

EPAS01-1

MODEL	MATERIAL	SIZE(H)	물품식별번호
EPAS01-101-1	AL	10m	22946248

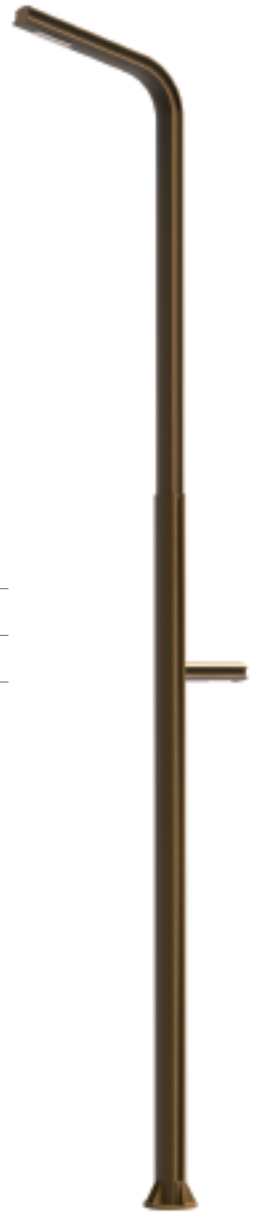



EPAS07

MODEL	MATERIAL	SIZE(H)	물품식별번호
EPAS07-081	AL	8m	23063282
EPAS07-0851	AL	8.5m	23063283
EPAS07-101	AL	10m	23063285

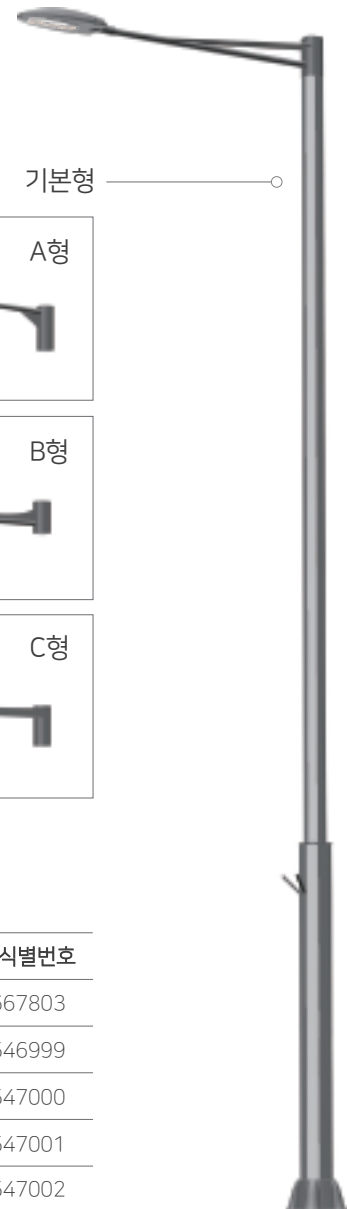

기본형

A형

B형

C형

EPAS10

MODEL	MATERIAL	SIZE(H)	물품식별번호
EPAS10-071	AL	7m	23667803
EPAS10-081	AL	8m	23546999
EPAS10-0851	AL	8.5m	23547000
EPAS10-091	AL	9m	23547001
EPAS10-101	AL	10m	23547002

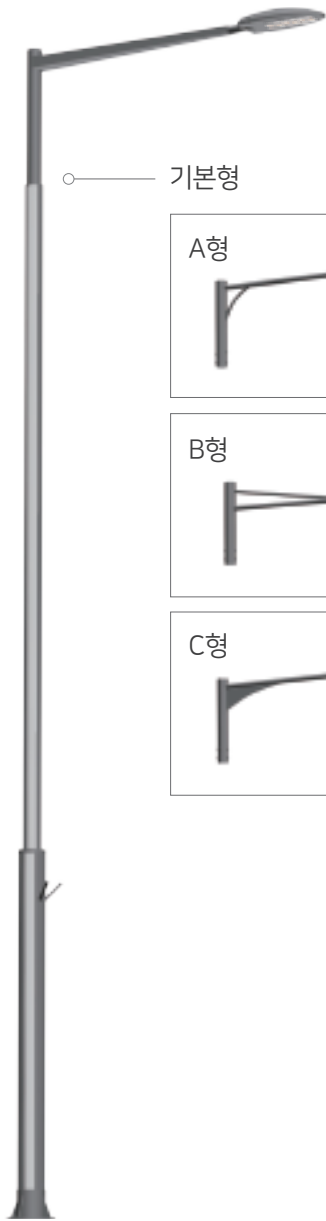

기본형

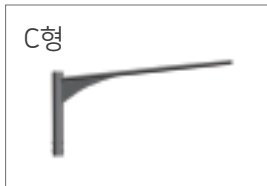
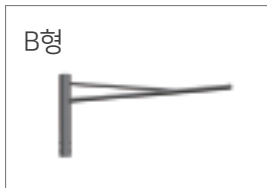
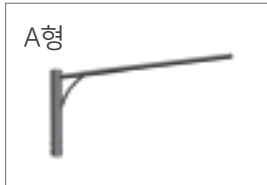

EPAS11

공공디자인인증 

MODEL	MATERIAL	SIZE(H)	물품식별번호
EPAS11-081	AL	8m	23547004
EPAS11-0851	AL	8.5m	23547005
EPAS11-091	AL	9m	23547006
EPAS11-101	AL	10m	23547007

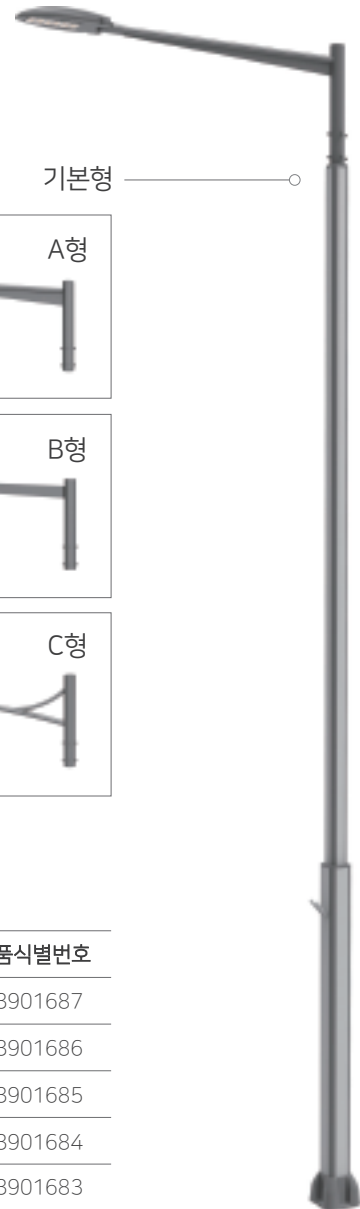

기본형

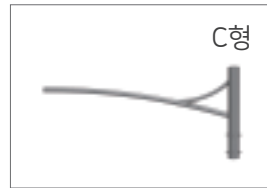
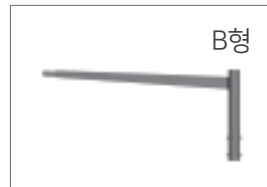
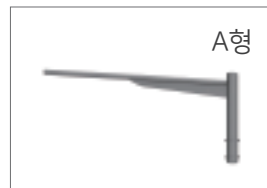

EPAS12

MODEL	MATERIAL	SIZE(H)	물품식별번호
EPAS12-071	AL	7m	23901687
EPAS12-081	AL	8m	23901686
EPAS12-0851	AL	8.5m	23901685
EPAS12-091	AL	9m	23901684
EPAS12-101	AL	10m	23901683



EPAS(P)

MODEL	MATERIAL	SIZE(H)	물품식별번호
EPAS(P)-09-1	STEEL	7.5m	22652960
EPAS(P)-12-1	STEEL	10.5m	22652962



2 보안등주



기본형

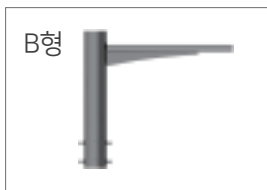
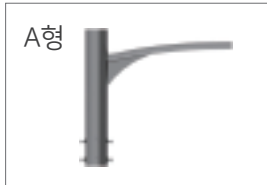

EPSP04

공공디자인인증  GDS
GOOD DESIGN

MODEL	MATERIAL	SIZE(H)	물품식별번호
EPSP04-041	STEEL	4m	23901681
EPSP04-051	STEEL	5m	23901680

기본형



EPSP06

MODEL	MATERIAL	SIZE(H)	물품식별번호
EPSP06-041	STEEL	4m	22469285
EPSP06-051-1	STEEL	5m	22652643





EPSP07

MODEL	MATERIAL	SIZE(H)	물품식별번호
EPSP07-051	STEEL	5m	23067717

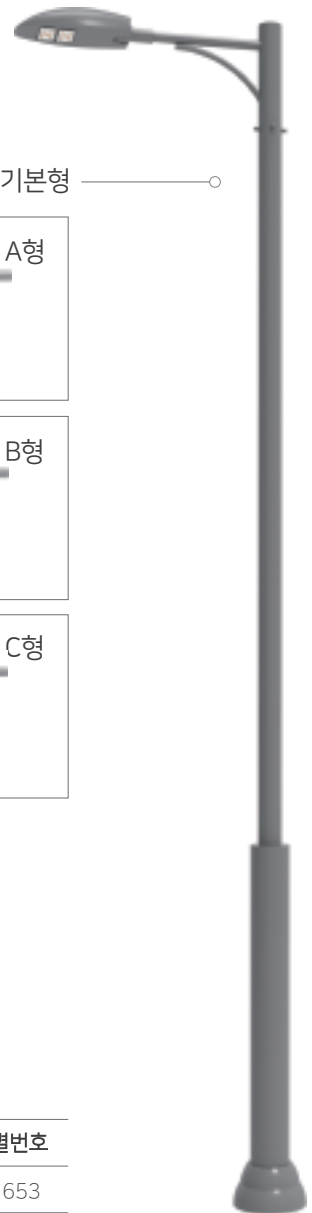

기본형 —○

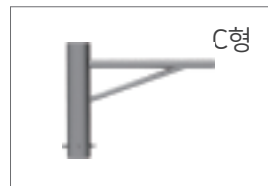
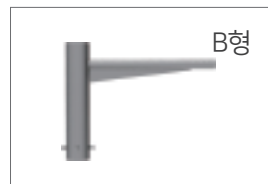
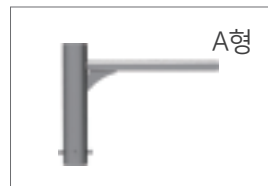

EPSP08

MODEL	MATERIAL	SIZE(H)	물품식별번호
EPSP08-051	STEEL	5m	23071653



EPSP10

MODEL	MATERIAL	SIZE(H)	물품식별번호
EPSP10-051	STEEL	5m	23320373
EPSP10-061	STEEL	6m	23681504



EPSP10-1

MODEL	MATERIAL	SIZE(H)	물품식별번호
EPSP10-0451	STEEL	4.5m	23316568



EPSP10-2

MODEL	MATERIAL	SIZE(H)	물품식별번호
EPSP10-0452	STEEL	4.5m	23316569

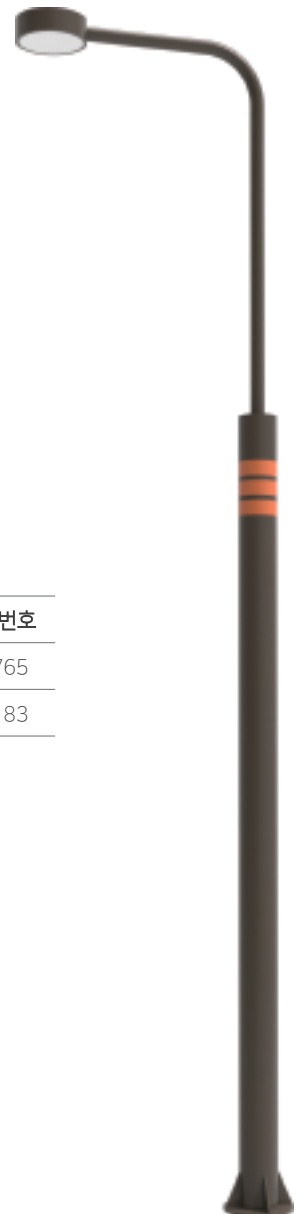

EPSP11

MODEL	MATERIAL	SIZE(H)	물품식별번호
EPSP11-041	STEEL	4m	23543765
EPSP11-051	STEEL	5m	23440183

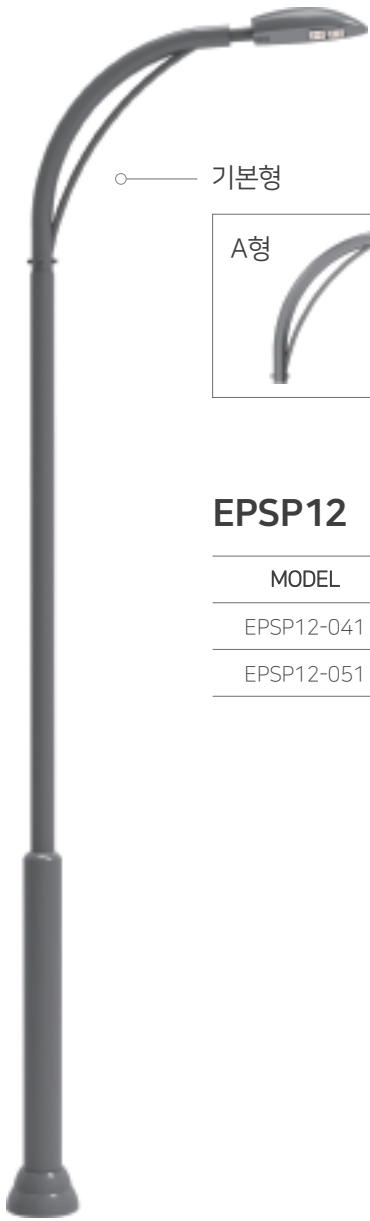

○ 기본형



EPSP12

MODEL	MATERIAL	SIZE(H)	물품식별번호
EPSP12-041	STEEL	4m	23901679
EPSP12-051	STEEL	5m	23901678

EPSP(P)

MODEL	MATERIAL	SIZE(H)	물품식별번호
EPSP(P)-045	STEEL	4.5m	22849751





EPSP(P)-1

MODEL	MATERIAL	SIZE(H)	물품식별번호
EPSP(P)-045-1	STEEL	4.5m	24115776

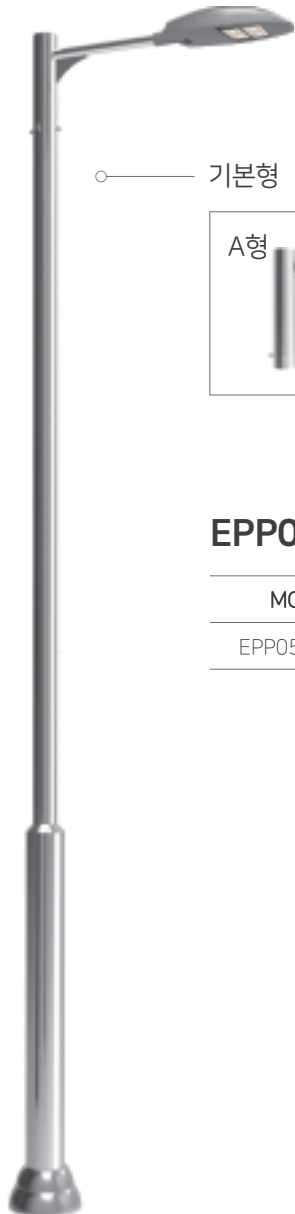

○ 기본형



EPP05

MODEL	MATERIAL	SIZE(H)	물품식별번호
EPP05-051-1	STS	5m	22652649



○ 기본형

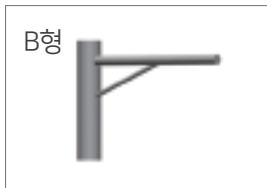

EPAP

MODEL	MATERIAL	SIZE(H)	물품식별번호
EPAP-041-1	AL	4m	22906275
EPAP-051-1	AL	5m	22652549
EPAP-061-1	AL	6m	23667804

EPAP(P)

공공디자인인증

MODEL	MATERIAL	SIZE(H)	물품식별번호
EPAP(P)-05-1	AL	4.5m	22652550





○ 기본형

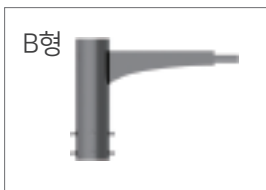
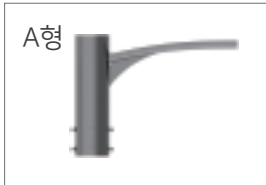

EPAP09

공공디자인인증



MODEL	MATERIAL	SIZE(H)	물품식별번호
EPAP09-051	AL	5m	23901688

EPAP08

공공디자인인증



MODEL	MATERIAL	SIZE(H)	물품식별번호
EPAP08-045	AL	4.5m	23901682





EPAP07

공공디자인인증 

MODEL	MATERIAL	SIZE(H)	물품식별번호
EPAP07-451	AL	4.5m	22703305



3 가로등주 부속자재



EPAC-06A 스테인리스 암

MODEL	SIZE(L)	물품식별번호
EPAC-06A	1.5~2.8m	22470617

EPAC-06B 스테인리스 암

MODEL	SIZE(L)	물품식별번호
EPAC-06B	1.5~2.8m	22470618



EPAC-20A 스테인리스 암

MODEL	SIZE(L)	물품식별번호
EPAC-20A	1.5~2.8m	22664641

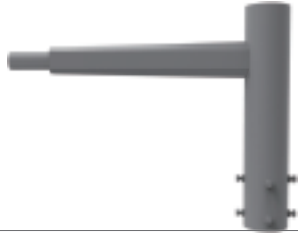

EPAC-16A 스테인리스 암

MODEL	SIZE(L)	물품식별번호
EPAC-16A	0.5m	22470629

EPAC-16B 스테인리스 암

MODEL	SIZE(L)	물품식별번호
EPAC-16B	0.5m	22470630



EPAC-27A 1등용암

MODEL	SIZE(L)	물품식별번호
EPAC-27A	0.45m	23338751

EPAC-27B 2등용암

MODEL	SIZE(L)	물품식별번호
EPAC-27B	0.45m	23338752





EPAC-13 보행등암

MODEL	SIZE(L)	물품식별번호
EPAC-13	0.6m	22470625

EPAC-19 보행등암

MODEL	SIZE(L)	물품식별번호
EPAC-19	0.3~0.5m	22704080

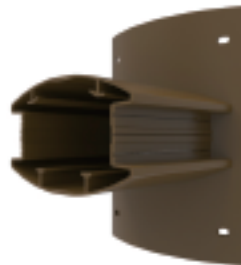

EPAC-29 보행등암

MODEL	SIZE(L)	물품식별번호
EPAC-29	0.6m	23547009

EPAC-26 한전주암

MODEL	SIZE(L)	물품식별번호
EPAC-26	1.0m	22965098





EPAC-21A 스테인리스 암

MODEL	SIZE(L)	물품식별번호
EPAC-21A	1.5~2.8m	22908968

EPAC-21B 스테인리스 암

MODEL	SIZE(L)	물품식별번호
EPAC-21B	1.5~2.8m	22908967



EPAC-26A 통합폴암

MODEL	SIZE(L)	물품식별번호
EPAC-26A	2m	23338749

EPAC-26B 통합폴암

MODEL	SIZE(L)	물품식별번호
EPAC-26B	2m	23338750





EPAC-11 단방향 배너걸이

MODEL	SIZE(L)	물품식별번호
EPAC-11	0.8m	22469025

EPAC-12 양방향 배너걸이

MODEL	SIZE(L)	물품식별번호
EPAC-12	0.8m	22469024



EPAC-22 베이스커버

MODEL	SIZE	물품식별번호
EPAC-22	Ø240×Ø410×245mm	22965094

EPAC-23 베이스커버

MODEL	SIZE	물품식별번호
EPAC-23	Ø240×Ø410×240mm	22965095



EPAC(P)-23 베이스커버 (공원등용)

MODEL	SIZE	물품식별번호
EPAC(P)-23	Ø175×Ø310×175mm	23913001



EPAC-24 베이스커버

MODEL	SIZE	물품식별번호
EPAC-24	Ø480 × 260mm	22965096

EPAC-25 베이스커버

MODEL	SIZE	물품식별번호
EPAC-25	Ø260×Ø420×270mm	22965097

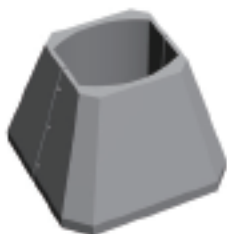
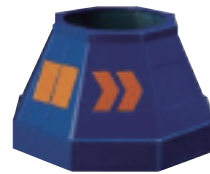

EPAC-28 베이스커버

MODEL	SIZE	물품식별번호
EPAC-28	□260 × □420 × 300mm	23430254



4 등기구



LED 가로등기구

100W / 125W / 150W

50,000시간 이상의 장수명
 효율이 높은 컨버터를 적용하여 높은 광효율을 구현
 방열, 방수, 배광 일체형 제품
 LED 표준모듈 탑재
 고효율에너지기자재 인증 취득



물품식별번호	23221750	23221751	23221752
모델명	EPL-ST-S100	EPL-ST-S125	EPL-ST-S150
환경표지인증	제 18677 호	제 18677 호	제 18677 호
고효율기자재	제 15286 호	제 15287 호	제 15288 호
전자파적합등록	R-REM-epl- EPL-ST-S100H	R-REM-epl- EPL-ST-S125H	R-REM-epl- EPL-ST-S150H

물품식별번호	23221750	23221751	23221752
모델명	EPL-ST-S100	EPL-ST-S125	EPL-ST-S150
소비전력	100W	125W	150W
LED	Lumileds	Lumileds	Lumileds
중량	6kg	6.3kg	6.7kg
방수등급	IP66	IP66	IP66
색온도	5,000K	5,000K	5,000K
연색성(Ra)	>75	>75	>75
정격광속	11,500 lm	14,375 lm	17,250 lm
광효율	115 lm/W 이상	115 lm/W 이상	115 lm/W 이상
배광곡선			

Out line dimation

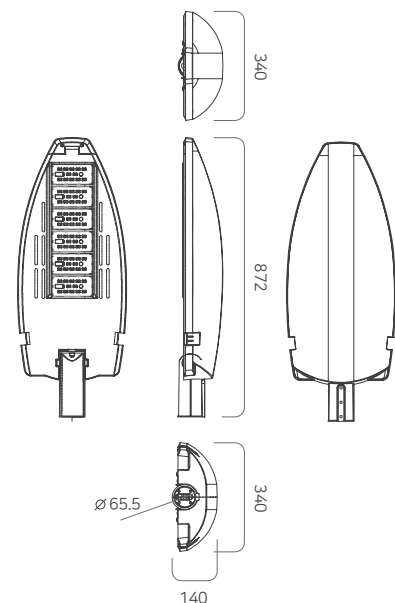



LED 보안등기구

40W / 50W / 60W / 75W

50,000시간 이상의 장수명
 효율이 높은 컨버터를 적용하여 높은 광효율을 구현
 방열, 방수, 배광 일체형 제품
 LED 표준모듈 탑재
 고효율에너지기자재 인증 취득

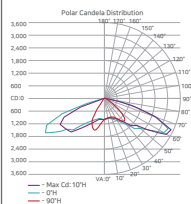
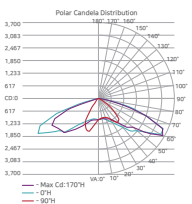
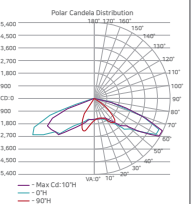
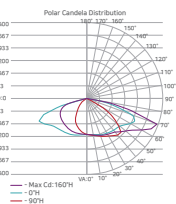

물품식별번호	23219874	23219875	23585123	23888878
모델명	EPL-SC-S40L	EPL-SC-S50	EPL-SC-S60	EPL-SC-S75
환경표지인증	제 18677 호	제 18677 호		
고효율기자재	제 14961 호	제 14983 호	제 20539 호	제 44730 호
전자파적합등록	R-REM-epl-EPL-SC-S40L	R-REM-epl-EPL-SC-S50H	R-REM-epl-EPL-SC-S60	R-R-epl-EPL-SC-S75

물품식별번호	23219874	23219875	23585123	23888878
모델명	EPL-SC-S40L	EPL-SC-S50	EPL-SC-S60	EPL-SC-S75
소비전력	40W	50W	60W	75W
LED	Lumileds	Lumileds	Lumileds	Lumileds
중량	3.4kg	3.4kg	3.4kg	3.4kg
방수등급	IP66	IP66	IP66	IP66
색온도	5,000K	5,000K	5,000K	5,000K
연색성(Ra)	>75	>75	>75	>75
정격광속	4,600 lm	5,750 lm	6,900 lm	8,625 lm
광효율	115 lm/W 이상	115 lm/W 이상	115 lm/W 이상	115 lm/W 이상
배광곡선				

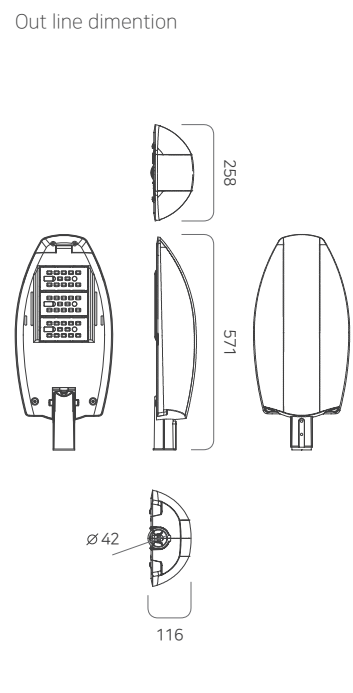



LED 보안등기구

70W

50,000시간 이상의 장수명
 효율이 높은 컨버터를 적용하여 높은 광효율을 구현
 방열, 방수, 배광 일체형 제품
 LED 표준모듈 탑재
 고효율에너지기자재 인증 취득



물품식별번호	23221740
모델명	EPL-LD70
 고효율기자재	제 13325 호
 전자파적합등록	R-R-epl-EPL-SC-S70

물품식별번호	23221740
모델명	EPL-LD70
소비전력	70W
LED	Lumileds
중량	5kg
방수등급	IP65
색온도	5,000K
연색성(Ra)	>75
정격광속	8,050 lm
광효율	115 lm/W 이상
배광곡선	

Out line dimation

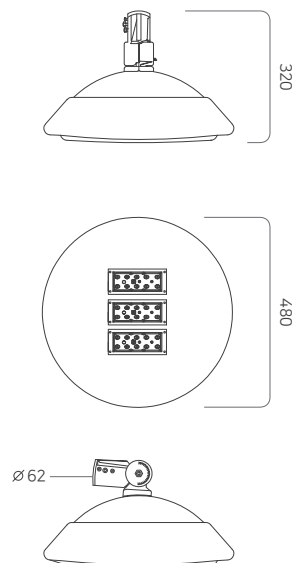



LED 보안등기구

70W

50,000시간 이상의 장수명
 효율이 높은 컨버터를 적용하여 높은 광효율을 구현
 방열, 방수, 배광 일체형 제품
 LED 표준모듈 탑재
 고효율에너지기자재 인증 취득

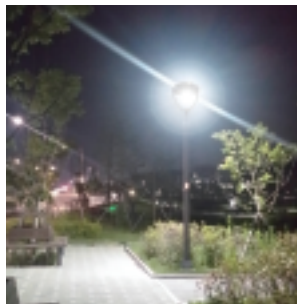

물품식별번호	23888879
모델명	EPL-SC-S70
 고효율기자재	제 45384 호
 전자파적합등록	R-R-epI-EPL-SC-S70

물품식별번호	23888879
모델명	EPL-SC-S70
소비전력	70W
LED	Lumileds
중량	8kg
방수등급	IP65
색온도	5,000K
연색성(Ra)	>75
정격광속	8,050 lm
광효율	115 lm/W 이상
배광곡선	

Out line dimation

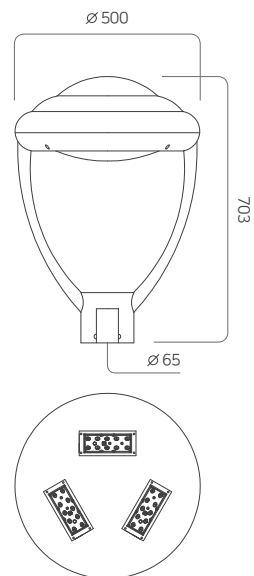

LED 터널용등기구

50W

50,000시간 이상의 장수명
 효율이 높은 컨버터를 적용하여 높은 광효율을 구현
 집광렌즈를 이용한 특허 설계
 고효율에너지기자재 인증 취득



물품식별번호	23340963	23340962
모델명	EPL-TL50(H)	EPL-TL50
고효율기자재	제 20529 호	제 20541 호
전자파적합등록	R-REM-ep-EPL-TL50H	R-REM-ep-EPL-TL50

물품식별번호	23340963
모델명	EPL-TL50(H)
소비전력	50W
LED	Lumileds
방수등급	IP66
색온도	5,000K
연색성(Ra)	>75
정격광속	5,750 lm
광효율	115lm/W이상

배광곡선

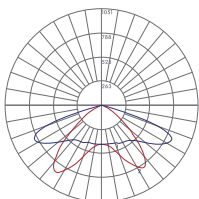

Out line dimention

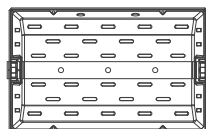
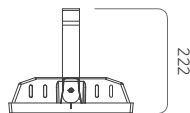
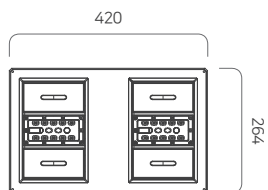

물품식별번호	23340962
모델명	EPL-TL50
소비전력	50W
LED	Lumileds
방수등급	IP66
색온도	5,000K
연색성(Ra)	>75
정격광속	5,750 lm
광효율	115lm/W이상

배광곡선

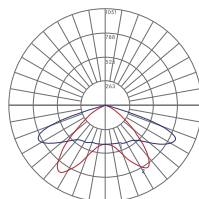

Out line dimention

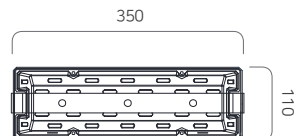
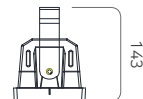
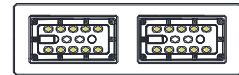

LED 터널용등기구
100W



물품식별번호	24033135
모델명	EPL-TL100A
☀️ 고효율기자재	제 51555 호
📄 전자파적합등록	R-R-epI-EPL-TL-100A

LED 투광등기구
90W / 120W

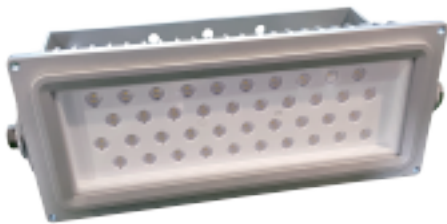

물품식별번호	23499201	23499202
모델명	EPL-FL90	EPL-FL120
☀️ 고효율기자재	제 29235 호	제 29236 호
📄 전자파적합등록	R-R-epI-EPL-FL90	R-R-epI-EPL-FL120

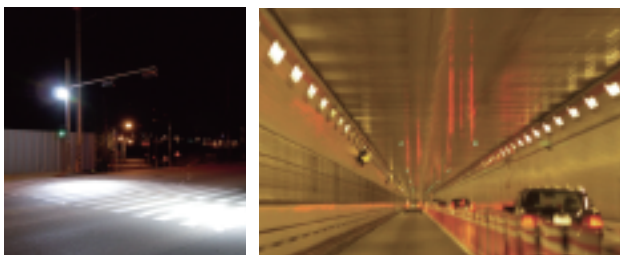

50,000시간 이상의 장수명
360도 회전 및 각도 조절 가능
집광 LENS 적용으로 특정부분(횡단보도 등)을 집중조명에 적합
고효율에너지기자재 인증 취득

물품식별번호	24033135	Out line dimention	
모델명	EPL-TL100A		
소비전력	100W		
LED	Lumileds		
방수등급	IP66		
색온도	5,000K		
연색성(Ra)	>75		
정격광속	11,500 lm		
광효율	115 lm/W 이상		
배광곡선			

물품식별번호	23499201	물품식별번호	23499202
모델명	EPL-FL90	모델명	EPL-FL120
소비전력	90W	소비전력	120W
LED	삼성 LED	LED	삼성 LED
방수등급	IP66	방수등급	IP66
색온도	5,000K	색온도	5,000K
연색성(Ra)	>75	연색성(Ra)	>75
정격광속	10,350 lm	정격광속	13,800 lm
광효율	115 lm/W 이상	광효율	115 lm/W 이상
배광곡선		배광곡선	

Out line dimention

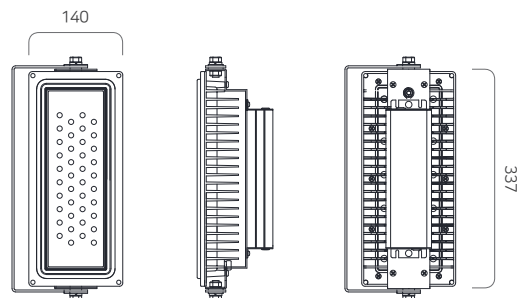

EPBL-E 보안등기구

MODEL	SOCKET	물품식별번호
EPBL-E	E26, E39	23337533



EPBL-A 보안등기구

MODEL	SOCKET	물품식별번호
EPBL-A	E26, E39	22379545



5 LED 경관조명기구



EPB-A

MODEL	LAMP	SIZE(H)	물품식별번호
EPB-A	12W이하	1000mm	22475529



EPB-B

MODEL	LAMP	SIZE(H)	물품식별번호
EPB-B	12W이하	1000mm	22475530



EPL-BL12A 야영장 블라드등

MODEL	LAMP	SIZE(H)	물품식별번호
EPL-BL12A	12W	800mm	23659725



EPL-BL12B 야영장 블라드등

MODEL	LAMP	SIZE(H)	물품식별번호
EPL-BL12B	12W	800mm	23659726



EPL-BO-001J

MODEL	LAMP	SIZE(H)	물품식별번호
EPL-BO-001J	6W	715mm	23835432



EPL-BO-002J

MODEL	LAMP	SIZE(H)	물품식별번호
EPL-BO-002J	8+7W	877mm	23837839



EPL-BO-003J

MODEL	LAMP	SIZE(H)	물품식별번호
EPL-BO-003J	8W	700mm	23835433



EPL-BO-004DY

MODEL	LAMP	SIZE(H)	물품식별번호
EPL-BO-004DY	10W	850mm	24157908



EPL-BO-005DY

MODEL	LAMP	SIZE(H)	물품식별번호
EPL-BO-005DY	10W	760mm	24157909



EPL-BO-006DY

MODEL	LAMP	SIZE(H)	물품식별번호
EPL-BO-006DY	16W	900mm	24157911



EPL-BO-007J

MODEL	LAMP	SIZE(H)	물품식별번호
EPL-BO-007J	13W	900mm	24155727



EPL-BO-008J

MODEL	LAMP	SIZE(H)	물품식별번호
EPL-BO-008J	15W	1000mm	24155730



EPL-BO-009DY

MODEL	LAMP	SIZE(H)	물품식별번호
EPL-BO-009DY	15W	650mm	24157916



EPL-BE-003DY

MODEL	LAMP	SIZE(H)	물품식별번호
EPL-BE-003DY	10W	405mm	24157913



EPL-BE-001J

MODEL	LAMP	SIZE(W×D×H)	물품식별번호
EPL-BE-001J	18W	300 × 300 × 254mm	23835430



EPL-BE-002J

MODEL	LAMP	SIZE(W×D×H)	물품식별번호
EPL-BE-002J	8W	270 × 270 × 370mm	23835431



EPL-LL-018DY

MODEL	LAMP	SIZE(W×D×H)	물품식별번호
EPL-LL-018DY	10W	86 × 115 × 148mm	24157902



EPL-LL-019DY

MODEL	LAMP	SIZE(W×D×H)	물품식별번호
EPL-LL-019DY	15W	132 × 150 × 186mm	24157903



EPL-LL-020DY

MODEL	LAMP	SIZE(W×D×H)	물품식별번호
EPL-LL-020DY	30W	132 × 155 × 186mm	24157904



EPL-LL-021DY

MODEL	LAMP	SIZE(W×D×H)	물품식별번호
EPL-LL-021DY	30W	160 × 200 × 270mm	24157920



EPL-LL-033DY

MODEL	LAMP	SIZE(W×D×H)	물품식별번호
EPL-LL-033DY	15W	150 × 205 × 208mm	24157917



EPL-LL-009S

MODEL	LAMP	SIZE(W×D×H)	물품식별번호
EPL-LL-009S	8W	80 × 70 × 234mm	23979301



EPL-FL-001T-W

MODEL	LAMP	SIZE(W×D×H)	물품식별번호
EPL-FL-001T-W	200W	360 × 330.8 × 430mm	23835437



EPL-FL-002T-F

MODEL	LAMP	SIZE(W×D×H)	물품식별번호
EPL-FL-002T-F	380W	362 × 500 × 430mm	23835439



EPL-LL-008I

MODEL	LAMP	SIZE(W×D×H)	물품식별번호
EPL-LL-008I	50W	254 × 365 × 63mm	24000859

EPL-LL-013I

MODEL	LAMP	SIZE(W×D×H)	물품식별번호
EPL-LL-013I	90W	254 × 365 × 63mm	24000860



EPL-FL-003T-F

MODEL	LAMP	SIZE(W×D×H)	물품식별번호
EPL-FL-003T-F	100W	356 × 210 × 113mm	23836042

EPL-LL-029J

MODEL	LAMP	SIZE(W×D×H)	물품식별번호
EPL-LL-029J	13W	60 × 60 × 341mm	24155726



EPL-LL-014A

MODEL	LAMP	SIZE(W×D×H)	물품식별번호
EPL-LL-014A	30W	230 × 150 × 75mm	24020443



EPL-LL-015A

MODEL	LAMP	SIZE(W×D×H)	물품식별번호
EPL-LL-015A	100W	331 × 155 × 158mm	24020444

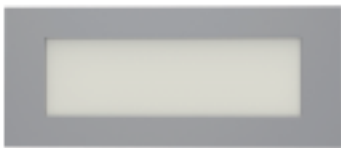

EPL-LL-010S

MODEL	LAMP	SIZE(W×D×H)	물품식별번호
EPL-LL-010S	3W	206 × 86 × 50mm	23979606



EPL-LO-001J

MODEL	LAMP	SIZE(W×D×H)	물품식별번호
EPL-LO-001J	6W	226 × 127 × 70 mm	23835434



EPL-LL-022DY

MODEL	LAMP	SIZE(W×D×H)	물품식별번호
EPL-LL-022DY	15+15W	150 × 215 × 297mm	24157905



EPL-LL-023DY

MODEL	LAMP	SIZE(W×D×H)	물품식별번호
EPL-LL-023DY	10W	230 × 230 × 65mm	24157906



EPL-LL-024DY

MODEL	LAMP	SIZE(W×D×H)	물품식별번호
EPL-LL-024DY	10W	90 × 85 × 120mm	24157907



EPL-LL-026DY

MODEL	LAMP	SIZE(W×D×H)	물품식별번호
EPL-LL-026DY	6W	125 × 70 × 105mm	24157912



EPL-IL31A

낮은도로조명

MODEL	LAMP	SIZE(L)	물품식별번호
EPL-IL31A	31W	0.78m	23607193

EPL-IL31A 설치사진

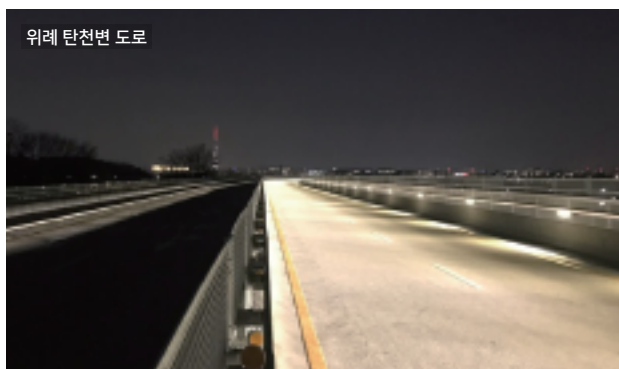

EPL-LL-012E

MODEL	LAMP	SIZE(W×D×H)	물품식별번호
EPL-LL-012E	150W	190 × 100 × 1342mm	23979303



EPL-LP50A

MODEL	LAMP	SIZE(H)	물품식별번호
EPL-LP50A	50 + 115W	5m	23659719



EPL-LP-50W

MODEL	LAMP	SIZE(H)	물품식별번호
EPL-LP-50W	50W	3.99m	23835440



EPL-LL-025DY

MODEL	LAMP	SIZE(H)	물품식별번호
EPL-LL-025DY	50W × 4	6m	24157910



EPL-LL-027DY

MODEL	LAMP	SIZE(H)	물품식별번호
EPL-LL-027DY	20 + 10W	3m	24157914



EPL-LL-028DY

MODEL	LAMP	SIZE(H)	물품식별번호
EPL-LL-028DY	55W	3.99m	24157915



EPL-LL-030J

MODEL	LAMP	HEIGHT	물품식별번호
EPL-LL-030J	50W	3.95m	24155728



EPL-LL-031J

MODEL	LAMP	SIZE(H)	물품식별번호
EPL-LL-031J	50W	3.95m	24155729



EPL-LL-032E

MODEL	LAMP	SIZE(H)	물품식별번호
EPL-LL-032E	50W	3.99m	24155731

공공디자인인증  



EPL-LL-034DY

MODEL	LAMP	SIZE(H)	물품식별번호
EPL-LL-034DY	35W	3.99m	24157918



EPL-LL-035DY

MODEL	LAMP	SIZE(H)	물품식별번호
EPL-LL-035DY	45W x 3	3.99m	24157919



EPL-LP50B

MODEL	LAMP	SIZE(H)	물품식별번호
EPL-LP50B	50 + 112W	4.1m	23659720



EPL-LP50C

MODEL	LAMP	SIZE(H)	물품식별번호
EPL-LP50C	50 + 112W	3.9m	23664224



EPL-WM

MODEL	LAMP	SIZE(H)	물품식별번호
EPL-WM80	80W	3.9m	23587712
EPL-WM100	100W	3.9m	23587713



EP20-SP04

공공디자인인증  

MODEL	LAMP	SIZE(H)	물품식별번호
EP20-SP04	50W	3.99m	23952966



EPL-CL-C50

MODEL	LAMP	SIZE(H)	물품식별번호
EPL-CL-C50	25 ~ 50W	2.5m	24130879



EPL-CL-S50

MODEL	LAMP	SIZE(H)	물품식별번호
EPL-CL-S50	25 ~ 50W	2.5m	24130880



스마트폴 Smart Pole

MODEL	SIZE(H)	물품식별번호
EPL-SP50	5m	23587714
EPL-SP75	6m	23587715
EPL-SP100	8m	23587716



EPL-SP50-OS49

MODEL	LAMP	SIZE(H)	물품식별번호
EPL-SP50-OS49	50W	5m	24116573



EPL-SP50-BS49

MODEL	LAMP	SIZE(H)	물품식별번호
EPL-SP50-BS49	50W	5m	24116572



EPL-SP50-OS55

MODEL	LAMP	SIZE(H)	물품식별번호
EPL-SP50-OS55	50W	5m	24116574



EPL-SP50-BS55

MODEL	LAMP	SIZE(H)	물품식별번호
EPL-SP50-BS55	50W	5m	24116575



EPL-SLP

MODEL	SIZE(H)	LAMP	물품식별번호
EPL-SLP100D	8m	100W	23824516
EPL-SLP125D	9m	125W	23824517
EPL-SLP150D	10m	150W	23824518
EPL-SLP40P	3.99m	40W	23824519
EPL-SLP50P	4.99m	50W	23824520
EPL-SLP60P	5.99m	60W	23824521



EPL-LL-016B

MODEL	LAMP	SIZE(W×D×H)	물품식별번호
EPL-LL-016B	15W	1000 × 12 × 22mm	24155724



EPL-LL-017B

MODEL	LAMP	SIZE(W×D×H)	물품식별번호
EPL-LL-017B	15W	1000 × 16 × 16mm	24155725



EPB-J

MODEL	LAMP	SIZE(L)	물품식별번호
EPB-J	24W	1.2m	23337004



EPB-K

MODEL	LAMP	SIZE(L)	물품식별번호
EPB-K	30W	2.4m	23337005



EPL-LL-007T-F

MODEL	LAMP	SIZE(L)	물품식별번호
EPL-LL-007T-F	10W	1m	23835429



EPL-LL

MODEL	LAMP	SIZE(L)	물품식별번호
EPL-LL-001D	2.9W	0.2m	23835423
EPL-LL-002D	7.2W	0.5m	23835424
EPL-LL-003D	14.4W	1m	23835425
EPL-LL-004D	4.3W	0.26m	23835426
EPL-LL-005D	8.6W	0.51m	23835427
EPL-LL-006D	17.3W	1m	23835428



6 블라드



EPBL-A04 고인장실리콘

MODEL	SIZE(W×D×H)	물품식별번호
EPBL-A04	140 × 70 × 800mm	22362993



EPBL-A05 우레탄

MODEL	SIZE(W×D×H)	물품식별번호
EPBL-A05	Ø150 × 800mm	22617796



EPBL-A06 우레탄

MODEL	SIZE(W×D×H)	물품식별번호
EPBL-A06	Ø120 × 800mm	23882041



7 스마트 가로등 및 스마트 폴

사물 및 관제서버 간

다양한 무선통신 네트워크 기술 적용

Wireless Communication Network Design & Optimization

RF LoRa WiFi Bluetooth NB-IoT LTE

스마트 가로등

- Pole-to-Pole
- Pole-to-Gateway
- Gateway-to-Server
- Server-to-Gateway
- Gateway-to-Pole
- Pole-to-Server
- Server-to-Pole

스마트 폴

- Pole-to-Smart Phone
- Pole-to-Mobility
- Pole-to-Vehicle
- Server-to-Server
- Pole-to-Pole

시계열 빅데이터 분석 Time-series Big Data Analysis

- | 교통량분석기반 도로유형, 구간별 Lighting Zone 설정
- | Lighting Zone별 다이نام릭 디밍 제어 설정
- | 고장분석 및 에너지 사용 패턴 분석
- | 도시시설물에 대한 시민 사용 패턴 분석
- | 도시 대기환경 정보 분석

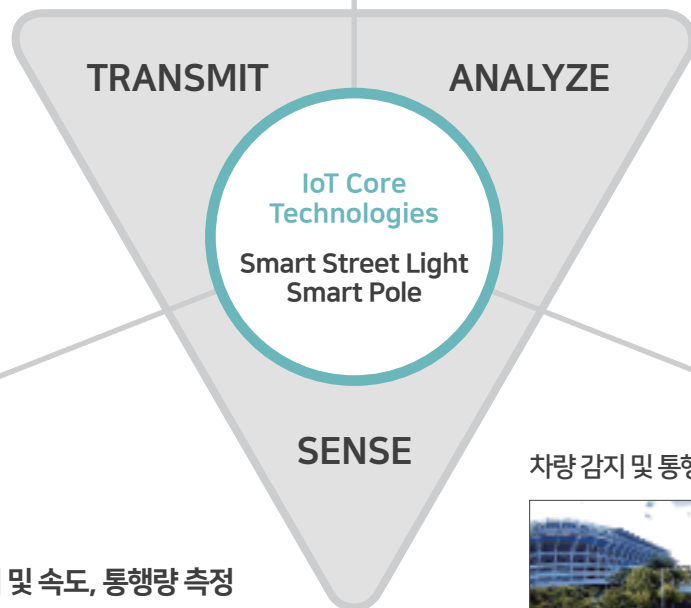
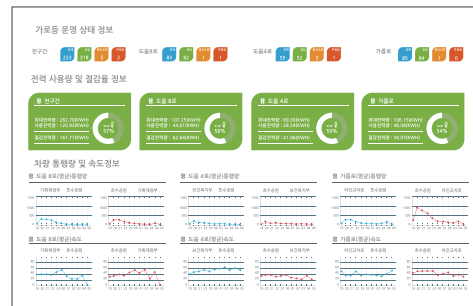

radar 센서 기반

도로상의 사물 감지 및 속도, 통행량 측정

Traffic and pedestrian counting by RADAR sensor

- | FMCW 레이더센서 기반의 차량 및 보행자 통행자 카운팅 디바이스를 도로 시설물(신호등주, 가로등주, 하이패스 등)에 설치
- | 통행량 측정 대상 도로의 환경 변수 (차선 수/폭, 장치 설치차선/높이, 감지거리 Min/Max, 감지속도 Max 및 감지각도)를 설정
- | 설치된 센서 디바이스로부터 취합되는 Raw Data에 Clustering과 Tracking 알고리즘을 적용하여 통행량과 속도 정보를 감지

디바이스 설치위치

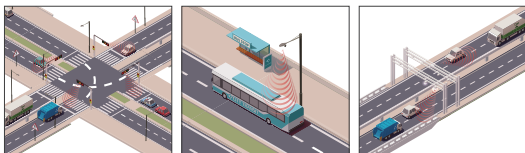

신호등주

가로등주

하이패스

차량 감지 및 통행량 측정

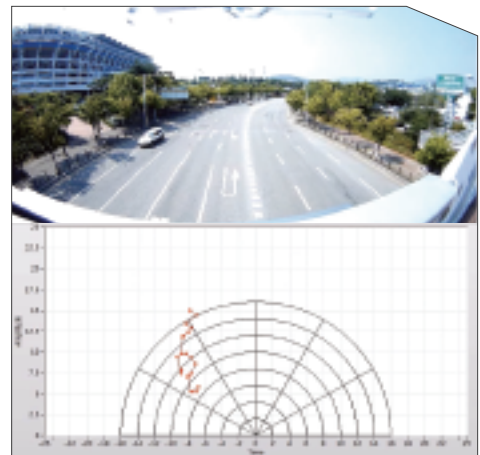

보행자 감지 및 통행량 측정



사물인터넷(IoT)기술 기반으로 “시간대별 주변의 밝기, 차량과 사람의 움직임과 통행량” 같은 동적인 도로 상황을 감지하여, 자동 또는 원격으로 가로등의 조도 및 동작이 제어되는 가로등

IoT technologies enable public street lights to recognize and sense movement of vehicles and pedestrians and control lightness by itself. The smart street light reduces energy consumption, light pollution and increases roadway safety.



안전한 도로조명



전기에너지 저감



빛 공해 감소



도시공익 정보 제공



교통량 빅 데이터 분석 기반 다이내믹 디밍 설정

Traffic Big Data Analysis

스마트센서에 의해 취합된 도로구간 별, 시간대 별 차량 통행량과 평균 속도 교통량 빅 데이터를 분석하여, 도로 구간 별, 가로등 별 기본 디밍율과 Lighting Zone 다이내믹 디밍 제어 Relay수를 차등 설정

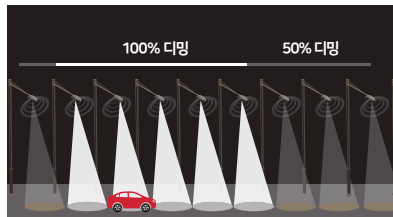

Lighting Zone 설정 및 다이내믹 디밍 제어

Dynamic Dimming Control by Lighting Zone

가로등의 밝기를 기본 디밍 수준으로 낮춘 상태에서 스마트센서에 의해 차량 접근이 감지되면, 차량의 속도를 감안하여 전방 100m까지 100% 디밍 수준으로 밝기를 밝게 조절하고, 차량이 통과하고 후속 차량이 없으면, 다시 밝기가 천천히 기본 디밍 수준으로 낮춰 지도록 밝기를 자동 제어



스마트 가로등 운영상태 및 전기에너지 사용/ 절감량 모니터링

Failure Detection and Energy Consumption Monitoring by Remote

스마트센서에 의해 취합된 가로등 별 운영상태(정상, 부점등, 통신이상) 및 전기에너지 사용량과 절감량 정보를 관제시스템을 통하여 모니터링
절감량 : **사용 전력량 42.6%** 절감, 전기요금 37.9% 절감

시스템 개요도 System Architecture

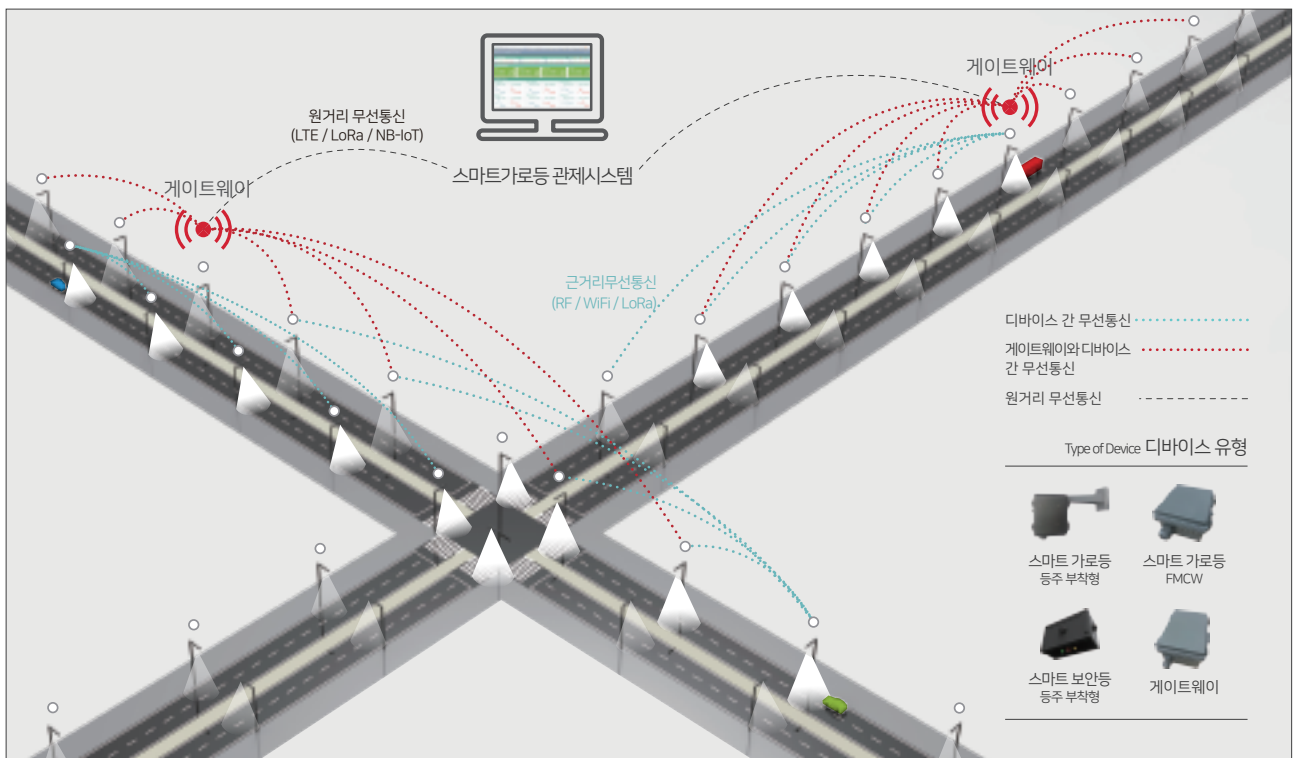

LED 보안등 조명에 스마트센서, 무선통신 및 원격 관제/빅 데이터 분석의 사물인터넷 기술을 융합하여 LED 보안등의 획기적인 전기에너지 저감, 주거 지역의 빛 공해 저감, 보행 시민의 안전, 유지관리 비용 절감 할 수 있는 스마트시티 서비스

IoT technologies enable public street lights to recognize and sense movement of vehicles and pedestrians and control lightness by itself. The smart street light reduces energy consumption, light pollution and increases roadway safety.



보행 시민의 안전 제고

보행 시민 감지에 따른 다이내믹 디밍
보행 안전 제고 및 범죄 예방



획기적인 전기에너지 저감

다이내믹 디밍 운용시 전기에너지 저감 55%이상
CO2 감소와 탄소세 절감(1.4원/kW)



주거 지역의 빛 공해 저감

시간대별 일괄 또는 개별 디밍제어



안전한 도시 보안등 유지 및 관리

점소등 시간 일괄 관리
부점등 등 다양한 고장 원인 관리



도시 및 주거 지역 공익 정보 제공

미세먼지 등 대기환경정보 수집 및 표출
IoT센서 & 무선망 활용 정보 획득
추가 센서 도입 가능

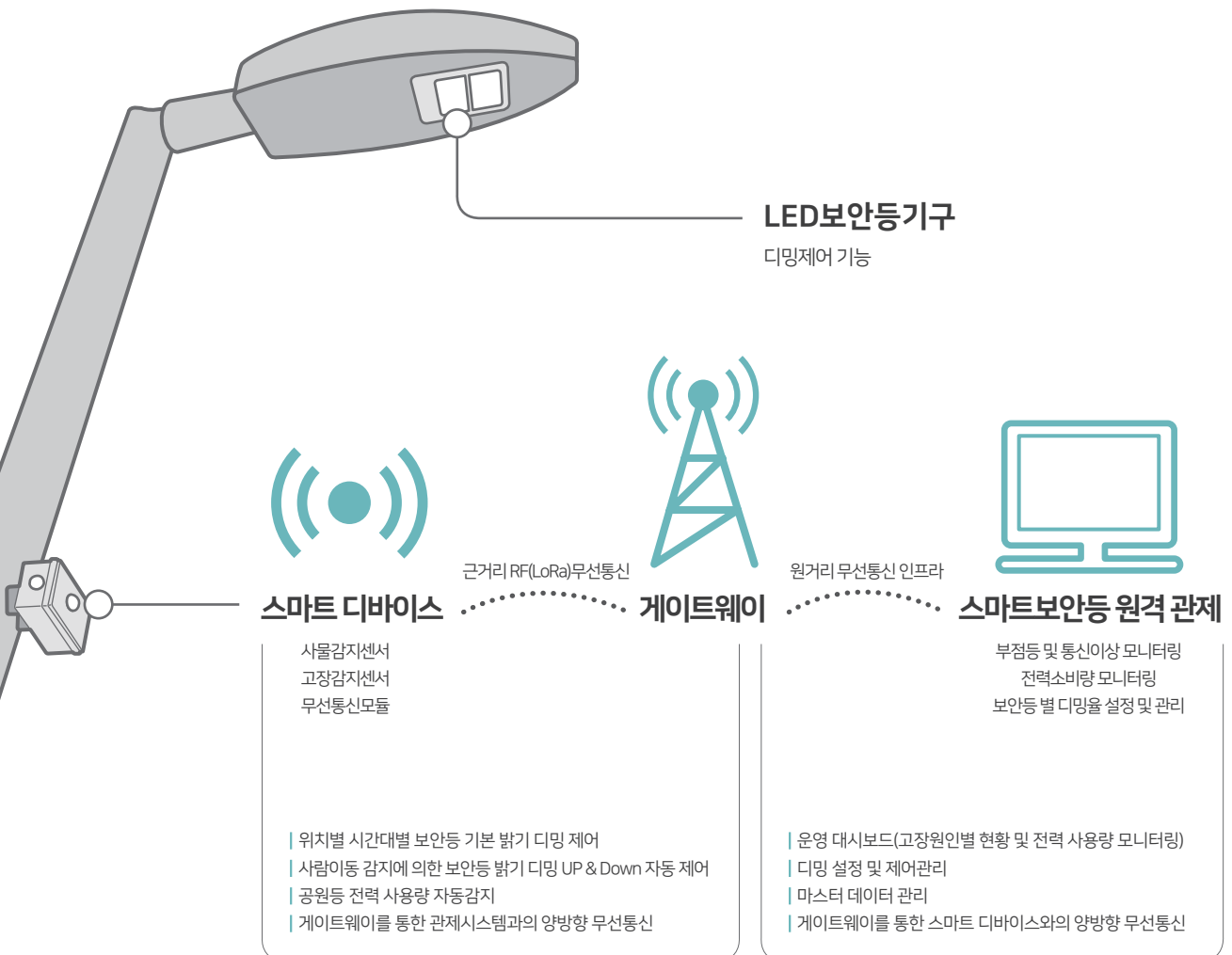

스마트 폴 Smart Pole

사물인터넷 기술 기반으로 시민 안전, 도시 범죄/테러 예방/감시, 시민 생활편의 제공 및 지능형교통시스템과 자율자동차를 위한 스마트 도로인프라 제공을 목적으로 제작된 고효율 스마트 도로조명 시스템

The Smart Pole is a turn-key Smart Product, utilizing IoT technologies embedded within steel and aluminum poles for public safety, crime prevention, surveillance, anti-terrorism and numerous lighting applications.



<p>고효율 스마트 도로조명 Smart & Intelligent Lighting System 도로 이용자 자동감지에 따른 조명 밝기 제어와 원격 자동 고장 감지</p>	<p>도로 돌발상황 감지 Road Incident Detection 주정차 역주행 도로파손 / 침수 경사지 붕괴 감지 센서 융합 (C-ITS 및 자율자동차 연계)</p>
<p>공공 Wifi 무선통신 인프라 Wifi Hotspot Service</p>	<p>자율자동차 무선통신 인프라 Pole-to-Vehicle (Bluetooth) Wireless Communication</p>
<p>영상 네트워크 City Surveillance HD CCTV Camera</p>	<p>대기환경정보 측정 Environmental Sensors 미세먼지 PM 10 초미세먼지 PM 2.5 이산화질소 NO₂ 일산화탄소 CO 아황산가스 SO₂</p>
<p>보안 SOS Application 비콘센서와 스마트폰 앱 연동 비상벨 양방향 스피커 경광등 영상센서</p>	<p>전기차 / 퍼스널 모빌리티 충전 서비스 EV / Personal Mobility Charging Service</p>
<p>LED 전광판 Signage LED 디스플레이 (지역정보 및 도시공익정보)</p>	

서비스 개요도 Service Overview

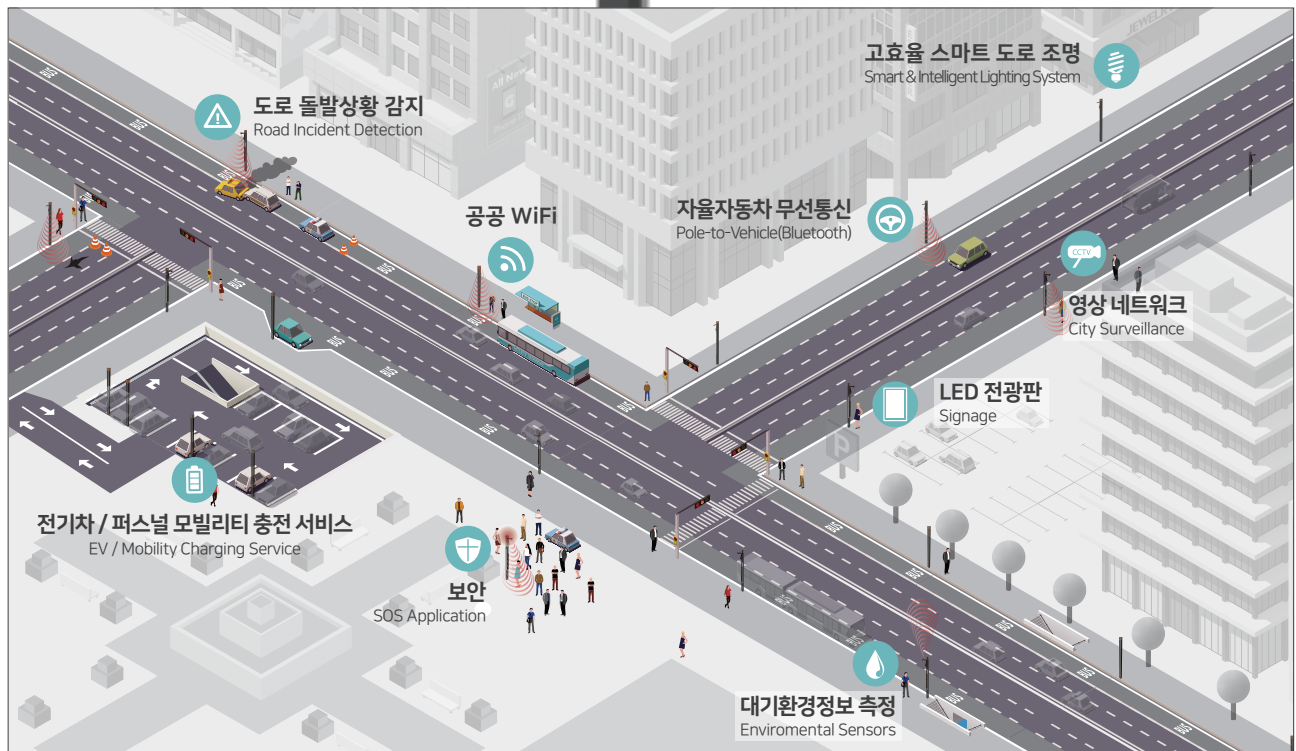



스마트가로등 디바이스 Smart Street Light Device

MODEL	물품식별번호	전자파적합등록
EPSLS-D (LoRa)	23673442	R-R-epl-EPSLS-D
EPSLS-R (릴레이)	23673443	R-R-epl-EPSLS-D
EPSLS-C (상시)	23673444	R-R-epl-EPSLS-D
EPSLS-F (FMCW, 속도 및 차량감지)	23673445	R-R-epl-EPSLS-F

스마트보안등 디바이스 Smart Security Light Device

MODEL	물품식별번호	전자파적합등록
EPSG-P3 (단독형)	23673448	R-R-epl-EPSG-P3N
EPSG-P3N (연계형)	23673447	R-R-epl-EPSG-P3N



자가망 게이트웨이 Self-netting Gateway

MODEL	물품식별번호	전자파적합등록
EPSSL-GW	23673446	R-R-epl-EPSLS-F

로라망 게이트웨이 LoRa Gateway

MODEL	물품식별번호	전자파적합등록
SIG-L0090	23971046	R-CS-epl-SIG-L0090



관제시스템 Control System

MODEL	물품식별번호
EPSPGM-SVR (보안등관제시스템)	23673888
EPSPLM-SVR (가로등관제시스템)	23673887



NEW 스마트가로등 디바이스
Smart Street Light Device

MODEL	물품식별번호	전자파적합등록
EPSLS-D0	24209583	R-R-epl-EPSLS-D0
EPSLS-DN	24209584	R-R-epl-EPSLS-D0
EPSLS-RN	24209587	R-R-epl-EPSLS-D0
EPSLS-CN	24209591	R-R-epl-EPSLS-D0
EPSLS-DS	24209592	R-R-epl-EPSLS-D0
EPSLS-RS	24209595	R-R-epl-EPSLS-D0
EPSLS-CS	24209599	R-R-epl-EPSLS-D0

NEW 스마트보안등 디바이스
Smart Security Light Device

MODEL	물품식별번호	전자파적합등록
EPSP-P30	24209603	R-R-epl-EPSP-P30
EPSP-P30N	24209604	R-R-epl-EPSP-P30
EPSP-P3RN	24209605	R-R-epl-EPSP-P30
EPSP-P3CN	24209606	R-R-epl-EPSP-P30
EPSP-P3NS	24209600	R-R-epl-EPSP-P30
EPSP-P3RS	24209601	R-R-epl-EPSP-P30
EPSP-P3CS	24209602	R-R-epl-EPSP-P30



NEW 자가망 게이트웨이
Self-netting Gateway

MODEL	물품식별번호	전자파적합등록
EPSLS-F0	24209607	R-R-epl-EPSLS-F0
EPSLS-FN	24209608	R-R-epl-EPSLS-F0
EPSLS-FS	24209609	R-R-epl-EPSLS-F0
EPSL-GWN	24209610	R-R-epl-EPSLS-F0



스마트폴 옵션 Smart Pole Option



스마트폴 Smart Pole

MODEL	SIZE(H)	물품식별번호
EPL-SP50	5m	23587714
EPL-SP75	6m	23587715
EPL-SP100	8m	23587716

LED 조명	LED 가로등기구, LED 보안등기구, 경관조명
센서	사물·사람 감지 센서 보도용 사물감지센서(사람 이동 감지) 물감지·충격감지·지진감지 센서 조도센서·공기질 센서·온습도센서·풍속센서
CCTV	회전형, 고정형
공공 Wi-Fi, 5G, 4G	공공 통신망 제공
충전기	모바일 충전기, 모빌리티 충전기, 전기자전거 충전기
디스플레이	LED, LCD
비상벨	경광등·스피커 연동, 관제 연결
스마트제터	공공 정보 이미지 제공



EPL-CL-C50

MODEL	LAMP	SIZE(H)	물품식별번호
EPL-CL-C50	25 ~ 50W	2.5m	24130879

EPL-CL-S50

MODEL	LAMP	SIZE(H)	물품식별번호
EPL-CL-S50	25 ~ 50W	2.5m	24130880



EPL-SP50

MODEL	LAMP	SIZE(H)	물품식별번호
EPL-SP50-OS49	50W	5m	24116573
EPL-SP50-BS49	50W	5m	24116572
EPL-SP50-OS55	50W	5m	24116574
EPL-SP50-BS55	50W	5m	24116575

강남구 LH 스마트움 스마트폴



김포시 신곡 6지구 스마트폴



김포시 풍무동 도시숲 스마트폴



김포시 장기동 금빛누리 스마트폴



김포시 풍무동 도시숲 스마트폴



김포시 장기동 금빛누리 스마트폴





세종특별시 스마트가로등



강동구 고덕강일 스마트보안등



김포시 마곡 시암 스마트가로등



서울식물원 스마트보안등



김포시 마곡 시암 스마트가로등



서울식물원 스마트보안등



경기도 김포시 하성면 귀전로 172-24
T : 031.989.8678 | F : 031.998.4673
www.epelkorea.co.kr | epelkorea@naver.com